



DAMP60/DAMP68

USER'S MANUAL



**DAMP60 AUTO RANGING AMP CLAMP METER/
DAMP68 AUTO RANGING TRUE RMS AMP CLAMP METER**

TABLE OF CONTENTS

TITLE	PAGE
FEATURES.....	3
FUNCTIONS DESCRIPTION.....	4-6
SAFETY INFORMATION.....	7-11
OPERATING INSTRUCTIONS.....	12-22
MAINTENANCE.....	22
SPECIFICATIONS.....	23-27
SAFETY COMPLIANCE.....	27

FEATURES

DAMP60

- Ergonomic Design
- Rugged Over-mold Housing
- Easy to use
- Data Hold, Max Hold
- Auto Ranging
- 3-1/2 Digit Jumbo LCD Display
- Continuity Buzzer, Diode Test
- Auto Power Off
- Includes Carrying Case & Test Leads

DAMP68

- Ergonomic Design
- Rugged Over-mold Housing
- Ideal for HVAC/R Applications
- True RMS
- Analog Bar Graph
- Easy to use
- Temperature
- Capacitance
- Range, Zero Button
- Auto Ranging
- 3-3/4 Digit Jumbo LCD Display
- Continuity Buzzer, Diode Test
- Auto Power Off
- Includes Carrying Case & Test Leads & K-Type Thermocouple

FUNCTION DESCRIPTION

These clamp meters have been designed for industrial use. They are high performance instruments offering a wide variety of measurements. Their over-mold housing as well as their ergonomic design makes them indispensable, durable and rugged for almost any situation or application.

DAMP60 is a 3-1/2 digit auto ranging digital display clamp meter. It measures DC/ACV; AC Current; Resistance; Diode Test; Continuity Buzzer and Frequency.

DAMP68 is a 3-3/4 digit auto/manual ranging digital display clamp meter with true RMS measurement. It measures true RMS AC/DC Voltage, Current, Resistance, Capacitance Frequency, Diode Test, Continuity Buzzer and Temperature Measurement.

● INSTRUMENTS OVERVIEW

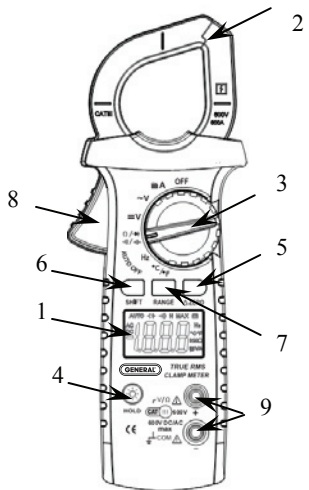

1. LCD Display
2. Clamp Jaw
3. Function Switch
4. Backlight (DAMP60)
Data Hold /Backlight (DAMP68)
5. Max Hold (DAMP60)
ZERO (DAMP68)
6. SHIFT
7. Hold (DAMP60)
Range (DAMP68)
8. Jaw Release
9. Input Terminal

LCD Display

DAMP60



DAMP68



SAFETY INFORMATION



To avoid possible electric shock or personal injury, follow these guidelines:

- ◆ Do not perform the performance tests or adjustment procedures described in this manual unless you are qualified to do so.
- ◆ The information provided in this manual is for the use of qualified personnel only.
- ◆ Read “Safety Information” before using this meter.
- ◆ These multimeters are battery operated, with a digital display.
- ◆ These Meters comply with IEC61010-1, 2001 CAT III 600V. Refer to “GENERAL SPECIFICATIONS” for more information.
- ◆ In this manual, a Warning identifies conditions and actions that pose hazards to the user.
- ◆ A Caution identifies conditions and actions that may damage the Meter or the equipment under test.

International symbols used on the Meter and in this manual are explained in Table 1 on page 11.

 **Warning**

To avoid possible electric shock or personal injury, and to avoid possible damage to the Meter or to the equipment under test, comply with the following practices:

1. Do not use the Meter in a manner not specified by this manual or the safety features of the Meter may be impaired.
2. Before using the Meter, inspect the case. Do not use the Meter if it is damaged. Look for cracks or missing plastic. Pay particular attention to the insulation around the connectors.
3.  **Warning** Inspect the test leads for damaged insulation or exposed metal. Check the test leads for continuity. Replace damaged test leads before using the Meter.
4. Verify a Meter's operation by measuring a known voltage. Do not use the Meter if it operates abnormally. Protection may be impaired. When in doubt, have the Meter serviced.
5.  **Warning** Do not apply more than the rated voltage, as marked on the Meter, between the terminals or between any terminal and earth ground.
6.  **Warning** Do not measure voltages above 600 V in Category III installations.

7. **Warning** Do not measure voltage when the function/range switch is set on the resistance (ohms), current, capacitance or temperature settings. Never measure current when the meter is set on the resistance (ohms), capacitance or temperature settings. Never measure AC voltage when the meter is set on DC voltage or DC current settings. Setting the meter on the incorrect function may burn out some of the internal circuitry and may pose a safety hazard.
8. Use caution when working with voltages above 30 V AC rms, 42 V AC peak, or 60 V DC. These voltages pose a shock hazard.
9. Use the proper terminals, function, and range for all measurements.
10. **Warning** Do not operate the Meter around explosive gas, vapor, or dust.
11. **Warning** When using the probes, keep the fingers behind the finger guards. Do not touch the metal probes of the test leads when making a measurement.
12. When making connections, connect the common test lead before connecting the live test lead; when disconnecting, disconnect the live test lead before disconnecting the common test lead.
13. Disconnect circuit power and discharge all high-voltage capacitors before testing resistance, continuity, diodes, or capacitance.















14. For all DC functions, including manual or auto-ranging, to avoid the risk of shock due to possible improper reading, verify the presence of any AC voltages by first using the AC function. Then select a DC voltage range equal to or greater than the AC range.
15. Do not operate the Meter with the case (or part of the case) removed.
16. Use only two “AAA” 1.5V batteries (DAMP60), or three “AAA” 1.5V batteries (DAMP68), properly installed in the Meter case, to power the Meter. Do not use rechargeable batteries.
17. Replace the battery as soon as the battery indicator “” appears. Operated with a low battery, the Meter might produce false readings that can lead to electric shock and personal injury.
18. Don't replace batteries with wrong type. Otherwise you may encounter hazards.
19. Remove test leads from the Meter before opening the Meter case or battery door.
20. When servicing the Meter, use only specified replacement parts.

Table 1. Electrical Symbols

Symbol	Description	Symbol	Description
	AC (Alternating Current)		Fuse
	DC (Direct Current)		Double Insulated
	Caution, risk of electric shock. Hazardous voltage.		Risk of danger. Important Information. Refer to the manual.
	Battery (Low battery) when shown on display		Earth ground
	Diode		Continuity/Beeper
	AC or DC		Complies with EU directives
	Application and removal from hazardous live conductors permitted	CAT III	For measurements performed in the building installation such as distribution panels, feeders and short branch circuits, and lighting systems in large buildings.

OPERATING INSTRUCTIONS

Button Description

- **Data Hold (DAMP60)**

Press the “H” (Hold) button to toggle in and out of the data hold mode. Use the data hold feature to lock the measurement reading on the display.

- **Max button (DAMP60)**

Press the “Max” button to record the maximum value measured over time.

- **SHIFT**

DAMP60: In $\overset{\wedge}{\rightarrow} \Omega \Delta$ range, press SHIFT button to select Resistance or Diode or Continuity function.

DAMP68:

Ω/\rightarrow
In \rightarrow/\rightarrow range, press SHIFT button to select resistance or diode or continuity or capacitance function.

$^{\circ}\text{C}/^{\circ}\text{F}$
In $^{\circ}\text{C}/^{\circ}\text{F}$ range, press SHIFT button to select $^{\circ}\text{C}$ or $^{\circ}\text{F}$ temperature measurement function.

$\approx\text{A}$
In $\approx\text{A}$ range, press SHIFT button to select ACA or DCA function.

• RANGE button (DAMP68)

The meter defaults to auto-ranging mode when powered on. In this mode, the meter automatically selects the best range to display the measurement. By pressing momentarily the Range button on the meter, the manual range mode will override the auto-ranging feature of the meter. To return to the auto-ranging mode, depress the Range button for more than 2 seconds.

• HOLD/Backlight Button (DAMP68)

Press this button momentarily to toggle in and out of the data hold mode. Use the data hold feature to lock the measurement reading on the display.

Press this button for more than 2 seconds to turn the backlight on and off. The backlight will remain lit for about 10 seconds before it automatically turns off to conserve battery power.

- **ΔZERO Button (DAMP68)**

This mode is used to zero out the display before measuring DC current. Press this button to subtract out the non-zero number and a “ΔZERO” appears on the display. Then, measure the DC amps. In auto-ranging mode, pressing this button again, the original offset number will be displayed.

- **AC/DC Current Measurement**

 **Warning**

Before taking current measurements, please make certain that all test leads are disconnected from the meter terminals.

- (1) Set the rotary switch at $\sim \mathbf{A}$ (DAMP60) or $\approx \mathbf{A}$ (DAMP68) position. For DAMP68, AC Current is default setting, press SHIFT button to select DC Current function. Before DC Current measurement, please press ΔZERO button to clear last reading from the display.
- (2) Press the trigger to open transformer jaw and to clamp one conductor only, making sure that the clamp is firmly closed around the conductor.
- (3) Read the measured result from the display. The measured result of (DAMP68) is true RMS.

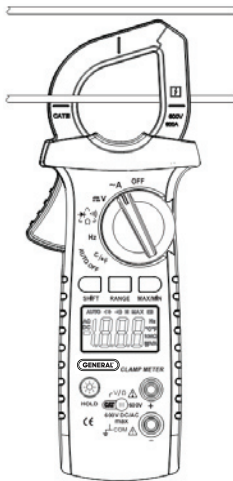

Notes:

- Clamp the jaw around one conductor only;
- Close the jaw completely;
- Center the wire in the jaw for highest accuracy.

• DC Voltage Measurement

Warning

Do not measure voltage higher than 600V. It may cause damage to internal circuit. If the voltage is over 1000 VDC, the beeper will sound for warning continuously, designating an over-range measurement.

- (1) Set the function/range switch to $\text{---}V$ position.
- (2) Insert the black and red test leads into the COM and V/ Ω input terminals respectively.
- (3) Touch the black test lead to the negative polarity, and touch the red test lead to positive polarity of the circuit to be tested.
- (4) Read the measured voltage on the display. If the test leads are reversed, the “-” indicator will appear on the display.

red test lead

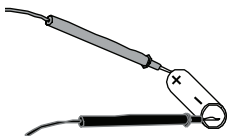

black test lead

red test lead

black test lead

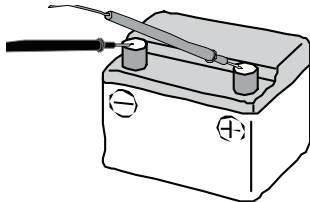

• AC Voltage Measurement

⚠ ⚠ Warning

Do not measure voltage higher than 600V. It may cause damage to internal circuit. If the voltage is over 750 VAC, the beeper will sound for warning continuously, designating an over-range measurement.

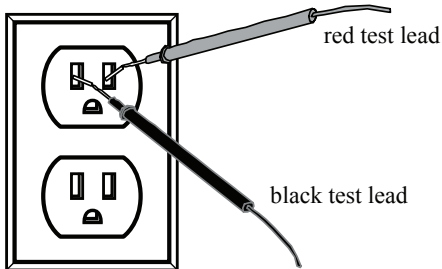

- (1) Set the function/range switch to $\sim V$ position.
- (2) Insert the black and red test leads into the COM and V/ Ω input terminals respectively.
- (3) Measure the voltage by touching the probes to the desired test points of the circuit.
With AC voltage, the polarity of the test lead is not a factor.
- (4) Read the measured voltage on the display.



• Resistance Measurement (Ω)

Warning

To avoid electrical shock or damage to the meter when measuring resistance or continuity in a circuit, make sure the power to the circuit is turned off and all capacitors are discharged.

- (1) Turn the rotary switch to  (DAMP60) or  (DAMP68). Make sure power is disconnected from the circuit to be measured. Resistance function is the default setting.
- (2) Insert the black and red test leads into the COM and V/ Ω input terminals respectively.
- (3) Measure the resistance by touching the probes to the desired test points of the circuit.
- (4) Read the measured resistance on the display. When the resistance value is over range, “OL” will be indicated on LCD display.

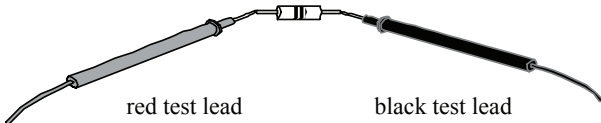

• Diode Check

- (1) Turn the rotary switch to $\rightarrow \wedge \rightarrow \Omega \rightarrow$ (DAMP60) or $\rightarrow \wedge \rightarrow \Omega \rightarrow \rightarrow$ (DAMP68) position. Press SHIFT button to select diode function.
- (2) Insert the black and red test leads into the COM and V/ Ω input terminals respectively.
- (3) Connect the red probe to the anode side and the black probe to the cathode side of the diode being tested.
- (4) Read the forward bias voltage value on the display.
- (5) If the polarity of the test leads is reversed with diode polarity, the display reading shows “OL”. This can be used to distinguish the anode and cathode sides of a diode.
- (6) For silicon diodes, forward bias voltage should be 0.5~0.8V, for germanium diodes, forward bias voltage should be 0.2~0.3V. “0 V” reading in both directions indicates a shorted diode, “OL” reading indicates an open diode. In either case, the diode is defective and should be replaced.

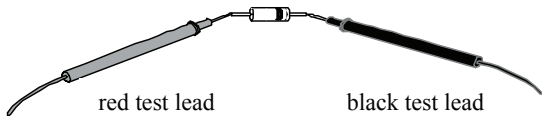

To measure temperature, do the following:

- (1) Turn the rotary switch to $^{\circ}\text{C}/^{\circ}\text{F}$ position. The $^{\circ}\text{C}$ feature is default setting. Press SHIFT button to select $^{\circ}\text{F}$ feature.
- (2) Connect a K-Type thermocouple to the Meter's COM and V/ Ω terminals, making sure the thermocouple plug marked with "+" is connected to V/ Ω terminal.
- (3) Read the measured temperature on the display.

• Capacitance Measurement (DAMP68)

Warning

To avoid possible damage to the Meter or other equipment, turn off the power source and discharge all high-voltage capacitors.

- (1) Disconnect the capacitor from power.
- (2) Short the terminals to discharge the capacitor.
- (3) Disconnect any resistors that might be between the terminals of the capacitor.
- (4) Set the rotary switch to the Ω/\rightarrow position. Press SHIFT button to select capacitance function.
- (5) Plug the black test lead into the COM port and the red test lead into the V/ Ω port.
- (6) Connect the test leads to the two terminals of the capacitor and measure the capacitance.
- (7) Read the measured capacitance value on the display.

• Frequency Measurement

- (1) Turn the rotary switch to **Hz** position.
- (2) Insert the black and red test leads into the COM and V/ Ω input terminals respectively.
- (3) Measure the frequency by touching the probes to the desired test points of the circuit.
- (4) Read the measured frequency on the display.

• Turn off

Please set the function switch to OFF position after using.

The Meter enters the “Sleep mode” and blanks the display if the Meter is not used and the input is inactive for 15 minutes. Press any button to wake the Meter up.

MAINTENANCE

Warning

If the Meter fails, check the batteries first, review this manual to make sure that you are operating the Meter correctly.

Disconnect test leads before opening the case or the battery door.

To avoid false readings, which could lead to possible electric shock or personal injury, replace the batteries as soon as the battery indicator “” appears.

GENERAL SPECIFICATIONS

ITEM NO.			
FUNCTIONS		DAMP60	DAMP68
Digital Display	Count	2000	4000
	Analog Bar graph	NA	Y
	Backlight	Y	Y
	Low battery indicator	Y	Y
	Overload indication	Y	Y
True RMS measurement		NA	Y
Auto/Manual		Auto	Auto/Manual
Auto power off		15 minutes	15 minutes
Data hold		Y	Y
RANGE		NA	Y
△ZERO		NA	Y

ITEM NO.			
FUNCTIONS		DAMP60	DAMP68
Min/Max		Max	NA
Over-molding rubber case		Y	Y
ACV	Range	1.999V/19.99V/ 199.9V/600V	400.0mV/ 4.000V/ 40.00V/ 400.0V/600V
	Accuracy	$\pm(1.0\%+5)$	$\pm(1.0\%+5)$ $\pm(2.0\%+10)$ for 400.0 mV only
DCV	Range	199.9mV/1.999V/ 19.99V/199.9V/ 600V	400.0mV/ 4.000V/40.00V/ 400.0V/600V
	Accuracy	$\pm(0.8\%+5)$	$\pm(0.8\%+5)$
ACA	Range	199.9/600A	400.0A
	Accuracy	$\pm(3.0\%+5)$	$\pm(3.0\%+10)$
DCA	Range	NA	400.0A
	Accuracy	NA	$\pm(3.0\%+5)$

ITEM NO.			
FUNCTIONS		DAMP60	DAMP68
Resistance (Ω)	Range	199.9 Ω /1.999K Ω / 19.99K Ω / 199.9K Ω / 1.999M Ω / 19.99M Ω	400.0 Ω /4.000K Ω / 40.00K Ω /400.0K Ω / 4.000M Ω /40.00M Ω
	Accuracy	<1M Ω \pm (1.0%+5) \geq 1M Ω \pm (2.0%+5)	<1M Ω \pm (1.0%+5) \geq 1M Ω \pm (2.0%+5)
Continuity (audible)		$\leq 50\Omega$	$\leq 50\Omega$
Diode test	Open circuit voltage	1.5V	2.7V
Capacitance	Range	NA	40.00nF/ 400.0nF/ 4.000 μ F/ 40.00 μ F/ 400.0 μ F/ 4000 μ F
	Accuracy	NA	\pm (4%+5)

ITEM NO.			
FUNCTIONS		DAMP60	DAMP68
Frequency counter	Range	10Hz ~1999Hz Input Voltage range: 0.2~30Vrms	99.99Hz/ 999.9Hz/ 9.999KHz/ 99.99KHz/ 999.9KHz/ 9.999MHz Input Voltage range: 0.2~600Vrms
	Accuracy	±(3%+10)	±2.0%
Temperature	Range	NA	-40° to 752°F (-40° to 400°C)
	Accuracy	NA	-40° to 4°F ±(8%+8) 4° to 32°F ±(1.2%+7) 32° to 212°F ±(1.2%+6) ≥212°F ±(3%+5)
Frequency response (Hz)		50/60Hz	50/60Hz
Withstand Voltage		6000V AC	6000V AC
Jaw	Type	Coil	Hall
	Opening	≥1.1" (28mm)	≥1.2" (31mm)

ITEM NO.		
FUNCTIONS	DAMP60	DAMP68
Operating Temperature	32° to 104°F (0° to 40°C) ≤75RH	32° to 104°F (0° to 40°C) ≤75RH
Power source	2 –AAA 1.5V	3-AAA 1.5V
Manual	Y	Y
Test Lead	20AWG CAT III 600V	20AWG CAT III 600V
Carrying Case	Y	Y
Temperature probe	NA	Y

SAFETY COMPLIANCE

Note: Accuracy is given for one year, at 23°±3°C, RH≤70%.

This unit was designed to be safe at least under the following conditions:

- Indoor use
- Altitude: up to 2000m
- Pollution degree: 2
- Ingress protection degree: IP20
- Test leads type: CE, CAT III 600V, 1A 
- Safety Compliance: IEC61010-1, CAT III 600V



Specialty Tools & Instruments™

GENERAL TOOLS & INSTRUMENTS™

80 White Street New York, NY 10013-3567

PHONE (212) 431-6100 • FAX (212) 431-6499 • TOLL FREE (800) 697-8665

e-mail: sales@generaltools.com • www.generaltools.com

DAMP60/DAMP68 User's Manual
Specifications subject to change without notice
©2009 GENERAL TOOLS & INSTRUMENTS™

NOTICE - WE ARE NOT RESPONSIBLE
FOR TYPOGRAPHICAL ERRORS.
MAN#DAMP60/DAMP68 7/09